

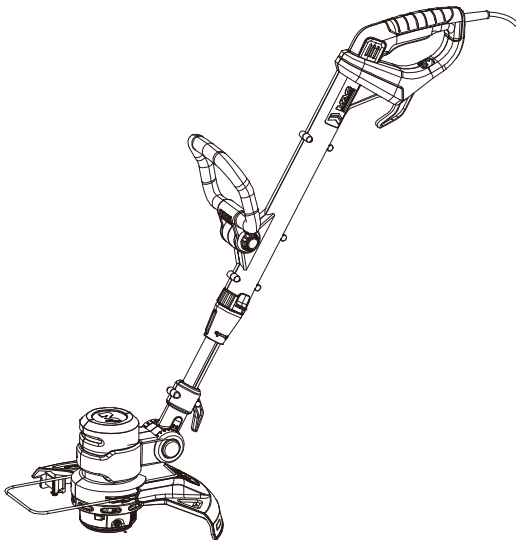

# Grass Trimmer 450W 28cm



## MGT45028



Original Instructions\_MNL\_MGT45028\_V1\_211025

WARNING: Read the instructions before using the product!

# Let's get started...

These instructions are for your safety. Please read through them thoroughly before use and retain them for future reference.



## Getting **started...** 02

<b>Safety</b> information	03
<b>Your</b> product	14
<b>Before</b> you start	15



## **In more detail...** 18

<b>Product</b> functions	19
<b>Operation</b>	23
<b>Care</b> and <b>maintenance</b>	28
<b>Troubleshooting</b>	33
<b>Recycling</b> and <b>disposal</b>	34
<b>Guarantee</b>	35
<b>Technical</b> specifications	37
<b>Declaration</b> of <b>conformity</b>	39

## Safety warnings

### General safety warnings

1. This appliance can be used by children aged from 8 years and above and persons with reduced physical, sensory or mental capabilities or lack of experience and knowledge if they have been given supervision or instruction concerning use of the appliance in a safe way and understand the hazards involved.
2. Children shall not play with the appliance.
3. Cleaning and user maintenance shall not be made by children without supervision.

### General power tool safety warnings



**WARNING!** Read all safety warnings, instructions, illustrations and specifications provided with this power tool. *Failure to follow all instructions listed below may result in electric shock, fire and/or serious injury.*

**Save all warnings and instructions for future reference.**

*The term “power tool” in the warnings refers to your mains-operated (corded) power tool or battery-operated (cordless) power tool.*

### Work area safety

1. **Keep work area clean and well lit.** *Cluttered or dark areas invite accidents.*
2. **Do not operate power tools in explosive atmospheres, such as in the presence of flammable liquids, gases or dust.** *Power tools create sparks which may ignite the dust or fumes.*
3. **Keep children and bystanders away while operating a power tool.** *Distractions can cause you to lose control.*

## Safety warnings

---

### Electrical safety

1. **Power tool plugs must match the outlet. Never modify the plug in any way. Do not use any adapter plugs with earthed (grounded) power tools.** *Unmodified plugs and matching outlets will reduce risk of electric shock.*
2. **Avoid body contact with earthed or grounded surfaces, such as pipes, radiators, ranges and refrigerators.** *There is an increased risk of electric shock if your body is earthed or grounded.*
3. **Do not expose power tools to rain or wet conditions.** *Water entering a power tool will increase the risk of electric shock.*
4. **Do not abuse the cord. Never use the cord for carrying, pulling or unplugging the power tool. Keep cord away from heat, oil, sharp edges or moving parts.** *Damaged or entangled cords increase the risk of electric shock.*
5. **When operating a power tool outdoors, use an extension cord suitable for outdoor use.** *Use of a cord suitable for outdoor use reduces the risk of electric shock.*
6. **If operating a power tool in a damp location is unavoidable, use a residual current device (RCD) protected supply.** *Use of an RCD reduces the risk of electric shock.*

### Personal safety

1. **Stay alert, watch what you are doing and use common sense when operating a power tool. Do not use a power tool while you are tired or under the influence of drugs, alcohol or medication.** *A moment of inattention while operating power tools may result in serious personal injury.*

2. **Use personal protective equipment. Always wear eye protection.** *Protective equipment such as dust mask, non-skid safety shoes, hard hat, or hearing protection used for appropriate conditions will reduce personal injuries.*
3. **Prevent unintentional starting. Ensure the switch is in the off-position before connecting to power source, picking up or carrying the tool.** *Carrying power tools with your finger on the switch or energising power tools that have the switch on invites accidents.*
4. **Remove any adjusting key or wrench before turning the power tool on.** *A wrench or a key left attached to a rotating part of the power tool may result in personal injury.*
5. **Do not overreach. Keep proper footing and balance at all times.** *This enables better control of the power tool in unexpected situations.*
6. **Dress properly. Do not wear loose clothing or jewellery. Keep your hair and clothing away from moving parts.** *Loose clothes, jewellery or long hair can be caught in moving parts.*
7. **If devices are provided for the connection of dust extraction and collection facilities, ensure these are connected and properly used.** *Use of dust collection can reduce dust-related hazards.*
8. **Do not let familiarity gained from frequent use of tools allow you to become complacent and ignore tool safety principles.** *A careless action can cause severe injury within a fraction of a second.*

## Power tool use and care

1. **Do not force the power tool. Use the correct power tool for your application.** *The correct power tool will do the job better and safer at the rate for which it was designed.*

## Safety warnings

---

2. **Do not use the power tool if the switch does not turn it on and off.** *Any power tool that cannot be controlled with the switch is dangerous and must be repaired.*
3. **Disconnect the plug from the power source and/or remove the battery pack, if detachable, from the power tool before making any adjustments, changing accessories, or storing power tools.** *Such preventive safety measures reduce the risk of starting the power tool accidentally.*
4. **Store idle power tools out of the reach of children and do not allow persons unfamiliar with the power tool or these instructions to operate the power tool.** *Power tools are dangerous in the hands of untrained users.*
5. **Maintain power tools. Check for misalignment or binding of moving parts, breakage of parts and any other condition that may affect the power tool's operation. If damaged, have the power tool repaired before use.** *Many accidents are caused by poorly maintained power tools.*
6. **Keep cutting tools sharp and clean.** *Properly maintained cutting tools with sharp cutting edges are less likely to bind and are easier to control.*
7. **Use the power tool, accessories and tool bits etc. in accordance with these instructions, taking into account the working conditions and the work to be performed.** *Use of the power tool for operations different from those intended could result in a hazardous situation.*
8. **Keep handles and grasping surfaces dry, clean and free from oil and grease.** *Slippery handles and grasping surfaces do not allow for safe handling and*

*control of the tool in unexpected situations.*

## Service

1. **Have your power tools serviced by a qualified repair person using only identical replacement parts. This will ensure that safety of the power tool is maintained.**

## Electrically powered grass trimmer safety warnings

**IMPORTANT  
READ CAREFULLY BEFORE USE  
KEEP FOR FUTURE REFERENCE**

## Training

1. Read the instructions carefully. Be familiar with the controls and the proper use of the product.
2. Never allow children, persons with reduced physical, sensory or mental capabilities or lack of experience and knowledge or people unfamiliar with these instructions to use the product. Local regulations may restrict the age of the operator.
3. Keep in mind that the operator or user is responsible for accidents or hazards occurring to other people or their property.

## Preparation

1. The machine should be supplied via a residual current device (RCD) with a tripping current of not more than 30 mA.
2. Before use check the supply and extension cord for signs of damage or aging. If the cord becomes damaged during use, disconnect the cord from the supply immediately. **DO NOT TOUCH THE CORD BEFORE DISCONNECTING THE SUPPLY.** Do not use the machine if the cord is damaged or worn.
3. Before use, always visually inspect the machine for damaged, missing or misplaced guards or shields.

## Safety warnings

---

4. Never operate the machine while people, especially children, or pets are nearby.

### Operation

1. Keep supply and extension cords away from cutting means.
2. Wear eye protection and stout shoes at all times while operating the machine.
3. Avoid using the machine in bad weather conditions especially when there is a risk of lightning.
4. Use the machine only in daylight or good artificial light.
5. Never operate the machine with damaged guards or shields or without guards or shields in place.
6. Switch on the motor only when the hands and feet are away from the cutting means.
7. Always disconnect the machine from the power supply (i.e. remove the plug from the mains, remove the disabling device or removable battery)
  - 1) whenever the machine is left unattended;
  - 2) before clearing a blockage;
  - 3) before checking, cleaning or working on the machine;
  - 4) after striking a foreign object;
  - 5) whenever the machine starts vibrating abnormally.
8. Take care against injury to feet and hands from the cutting means.
9. Always ensure that the ventilation openings are kept clear of debris.

### Maintenance and storage

1. Disconnect the machine from the power supply (i.e. remove the plug from the mains, remove the disabling device or removable battery) before carrying out maintenance or cleaning work.



2. Use only the manufacturer's recommended replacement parts and accessories.
3. Inspect and maintain the machine regularly. Have the machine repaired only by an authorized repairer.
4. When not in use, store the machine out of the reach of children.
5. If the supply cord is damaged, it must be replaced by a special cord or assembly available from the manufacturer or its service agent.

### **Vibration and noise reduction**

**To reduce the impact of noise and vibration emission, limit the time of operation, use low-vibration and low-noise operating modes as well as wear personal protective equipment.**

Take the following points into account to minimise the vibration and noise exposure risks:

1. Only use the product as intended by its design and these instructions.
2. Ensure that the product is in good condition and well maintained.
3. Use correct attachments for the product and ensure they are in good condition.
4. Keep tight grip on the handles/grip surface.
5. Maintain this product in accordance with these instructions and keep it well lubricated (where appropriate).
6. Plan your work schedule to spread any high vibration tool use across a longer period of time.
7. Prolonged use of the product exposes the user to vibrations that can cause a range of conditions collectively known as hand-arm vibration syndrome (HAVS) e.g. fingers going white; as well as specific diseases such as carpal tunnel syndrome. To reduce this risk when using the product, always wear protective gloves and keep your hands warm.

## Safety warnings

---

### Emergency

**Familiarise yourself with the use of this product by means of this instruction manual. Memorise the safety directions and follow them to the letter. This will help to prevent risks and hazards.**

- 1. Always be alert when using this product, so that you can recognise and handle risks early. *Fast intervention can prevent serious injury and damage to property.***
- 2. Switch the product off and disconnect from the power supply if there are malfunctions. *Have the product checked by a qualified professional and repaired, if necessary, before you operate it again.***

## Residual risks

**Even if you are operating this product in accordance with all the safety requirements, potential risks of injury and damage remain. The following dangers can arise in connection with the structure and design of this product:**

















1. Health defects resulting from vibration emission if the product is being used over long periods of time or not adequately managed and properly maintained.
2. Injuries and damage to property due to broken attachments or the sudden impact of hidden objects during use.
3. Danger of injury and property damage caused by flying objects.



**WARNING!** This product produces an electromagnetic field during operation! This field may under some circumstances interfere with active or passive medical implants! To reduce the risk of serious or fatal injury, we recommend persons with medical implants to consult their doctor and the medical implant manufacturer before operating this product!

## Symbols

On the product, the rating label and within these instructions you will find among others the following symbols and abbreviations. Familiarise yourself with them to reduce hazards like personal injuries and damage to property.

V~	Volt, (alternating voltage)	Hz	Hertz
/min or min <sup>-1</sup>	Per minute	W	Watt
g	Gram	kg	Kilogram
mm	Millimetre	cm	Centimeter
dB(A)	Decibel (A-rated)	m	Metre
	Lock / to tighten or secure.	m/s <sup>2</sup>	Metres per second squared
	Read the instruction manual.		Unlock / to loosen.
			Note / Remark.
xxWyy	Manufacturing date code; year of manufacturing (20xx) and week of manufacturing (Wyy)		Caution / Warning.
	Wear hearing protection.		Wear eye protection.
	Wear a dust mask.		Wear protective gloves.
	Wear protective, slip-resistant footwear.		
	Wear tight-fitted protective clothes.		
	Switch the product off and disconnect it from the power supply before assembly, cleaning, adjustments, maintenance, storage and transportation.		
	Do not expose the product to rain or wet conditions (moisture).		
	Objects thrown by the product could hit the user or other bystanders. Always ensure that other people and pets remain at a safe distance from the product when it is in operation. In general, children must not come near the area where the product is.		
			

## Symbols



Inspect the area where the product is to be used and remove all objects which can be thrown by the product. If objects are hidden while operating stop the motor and remove the object.



Keep other people out of working area during operation. A distance of at least 15 m must be observed.



Disconnect the product from the mains plug if the cord is damaged or entangled. **DON'T TOUCH THE CORD BEFORE DISCONNECTING THE SUPPLY.**



Contact of the guide bar tip with any object should be avoided.



Guaranteed sound power level value in 96 dB.



The product is of Protection class II. That means it is equipped with enhanced or double insulation.



The product complies with the applicable European directives and an evaluation method of conformity for these directives was done.



UK Conformity Assessed.



WEEE symbol. Waste electrical products should not be disposed of with household waste. Please recycle where facilities exist. Check with your Local Authority or local store for recycling advice.

## Your product

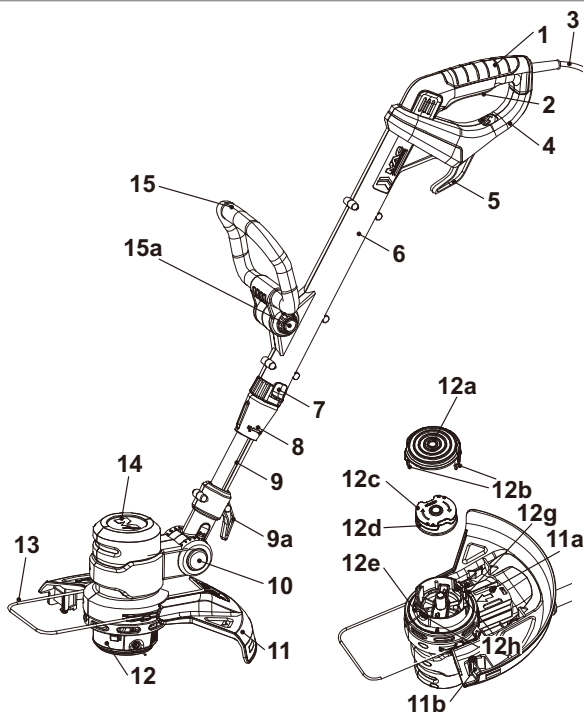

- |   |                                       |                        |
|---|---------------------------------------|------------------------|
| 1. Main handle                          | 10. Unlock button for tilt adjustment | d. Trimming line (x2)  |
| 2. On/off switch                        | a. Indicator*                         | e. Housing             |
| 3. Power cord with plug                 | b. Indication line*                   | f. Sliding slot (x2)*  |
| 4. Rear safeguard                       | 11. Guard                             | g. Release push button |
| 5. Cord retainer (rotatable)            | a. Screw                              | h. Eyelet              |
| 6. Upper pole                           | b. Knife                              | i. Screw hole*         |
| 7. Unlock button for angle adjustment   | c. Screw hole*                        | 13. Plant protector    |
| 8. Locking sleeve for length adjustment | d. Knife protector*                   | 14. Motor housing      |
| 9. Lower pole                           | 12. Trimmer head                      | 15. Auxiliary handle   |
| a. Cord retainer(fixed)                 | a. Cover                              | a. Lock button         |
|   | b. Release latch (x2)                 |                        |
|   | c. Trimming spool                     |                        |



**NOTE:** Parts marked with \* are not shown in this overview. Please refer to the respective part in the instruction manual.

## Unpacking

1. Unpack all parts and lay them on a flat, stable surface.
2. Remove all packing materials and shipping devices if applicable.
3. Make sure the delivery contents are complete and free of any damage. If you find that parts are missing or show damage do not use the product but contact your dealer. Using an incomplete or damaged product represents a hazard to people and property.
4. Ensure that you have all the accessories and tools needed for assembly and operation. This also includes suitable personal protective equipment.



**WARNING!** The product and the packaging are not children's toys! Children must not play with plastic bags, sheets and small parts! There is a danger of choking and suffocation!

## You will need

(items not supplied)

Suitable personal protective equipment

Suitable crosshead screwdriver

(items supplied)

Guard (11)

Screw (11a)



**NOTE:** The accessories required depend on the intended application. Ask your dealer for advice.

## Setup



**WARNING!** The product must be fully assembled before operation! Do not use a product that is only partly assembled or assembled with damaged parts!



Follow the assembly instructions step-by-step and use the pictures provided as a visual guide to easily assemble the product! Do not connect the product to battery pack (20) before it is completely assembled!



**NOTE:** Take care of small parts that are removed during assembly or when making adjustments. Keep them secure to avoid loss.

## Setup

### Guard

1. Turn the trimmer head (12) upside down.
2. Put out the plant protector (13) firstly (Fig. 1, step 1), then align and slide the guard (11) onto the sliding slots (12f) of the trimmer head (12) (Fig. 1, step 2). Fully insert the guard (11) and make sure that the screw holes (11c, 12i) are well aligned.
3. Secure the guard (11) with the screw (11a) in clockwise (Fig. 1, step 3).

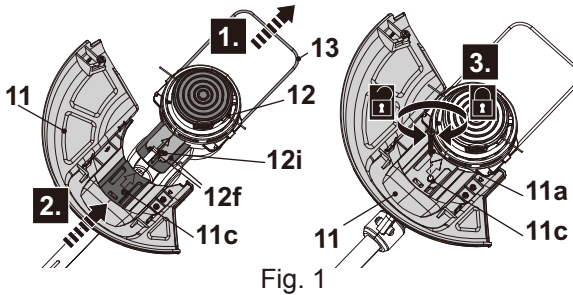

**WARNING!** Never use the trimmer head (12) without the guard (11) properly fitted.



**NOTE:** Always remove knife protection (11d) before use.



## Connection to power supply



**NOTE:** The product is equipped with a power cord with the length of 10 m. If a proper extension cord is required for operation. Observe the technical requirements for this product when purchasing an extension cord.

Always use a residual current supply (RCD) protected supply.

1. Rotate the cord container (rotatable) (5) and make sure that the tip of cord container (rotatable) (5) is pointed forward.
2. Double the power cord (3) back, about 60 cm from the power guard and lead the loop through the hole of the rear safeguard (4). Pull it over the cord retainer (5) and gently tug on the power cord (3) to ensure that it is firmly secured (Figs. 2, 3).

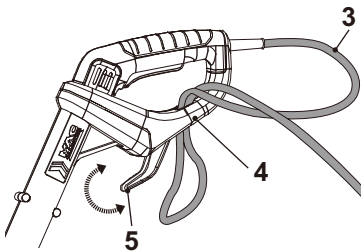

Fig. 2

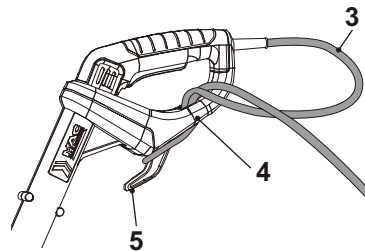

Fig. 3

3. Connect the plug of power cord (3) with a suitable socket.



**WARNING!** Check the voltage! The voltage must comply with the information on the rating label!

If using an extension cord it must be suitable for outdoor use with sockets protected against water splashing.

Ensure the extension cord is of the proper size and type for your product:

- 1.5 mm<sup>2</sup> for up to 60 m
- 2.5 mm<sup>2</sup> for up to 100 m

4. Your product is now ready to be used.

# In more detail...



<b>Product functions</b>	19
<b>Operation</b>	23
<b>Care and maintenance</b>	28
<b>Troubleshooting</b>	33
<b>Recycling and disposal</b>	34
<b>Guarantee</b>	35
<b>Technical specifications</b>	37
<b>Declaration of conformity</b>	39



## Intended use

This electric grass trimmer MGT45028 is designated with a rated power input of 450 Watts.

The product is intended for cutting weed, grass or similar soft vegetation in areas that are hard to reach, e. g. under bushes, on slopes and edges. It may not be used to work on unusual thick, dry or wet grass, e. g. pasture grass, or to shred leaves.

For safety reasons it is essential to read the entire instruction manual before first operation and to observe all the instructions therein.

This product is intended for private domestic use only, not for any commercial trade use. It must not be used for any purposes other than those described.

## Auxiliary handle adjustment

Adjust the angle of the auxiliary handle (15) to fit the intended application.

1. Press down the lock button (15a) and hold it in position, then rotate the auxiliary handle (15) upward or downward to adjust the angle (Fig. 4).
2. Release the lock button (15a), and continue to gently swing the auxiliary handle (15) until it locks in place. Ensure the tooth system locks in place.

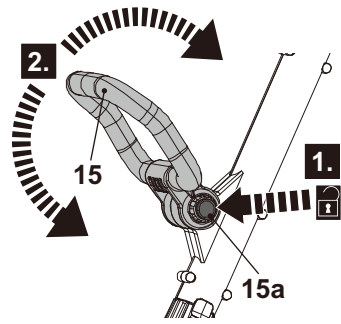

Fig. 4

## Length adjustment

Adjust the pole length to fit the body height.

1. Loosen the locking sleeve (8) in clockwise (Fig. 5, step 1).
2. Pull the lower pole (9) out or push it together to adjust the desired length (Fig. 5, step 2).
3. Tighten the locking sleeve (8) in anticlockwise (Fig. 5, step 3).

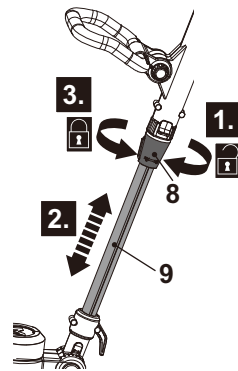

Fig. 5

## Main handle angle adjustment

Adjust the main handle (1) to either 0° for trimming or 90° / 180° for edging.

1. Slide the unlock button (7) downward and turn the main handle (1) clockwise while holding lower pole (9) to adjust the trimmer head (12) to an angle of 90° or 180° (Fig. 6). Release the unlock button (7) and keep turning the main handle (1) until it locks in place. Ensure the unlock button (7) snaps into place.
2. Slide the unlock button (7) downward and turn the main handle (1) anticlockwise while holding lower pole (9) to adjust the trimmer head (12) to an angle of 0° (Fig. 7 A, B). Release the unlock button (7) and keep turning the main handle (1) until it locks in place. Ensure the unlock button (7) snaps into place.

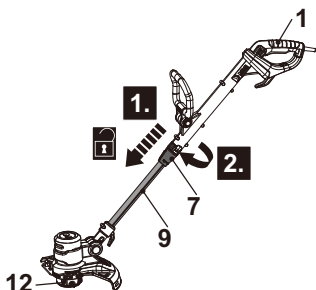

Fig. 6 (initial position 0°)

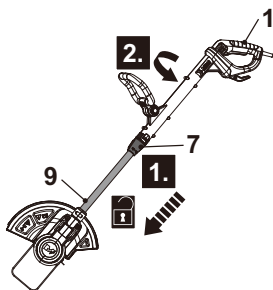

Fig. 7 A (initial position 90°)

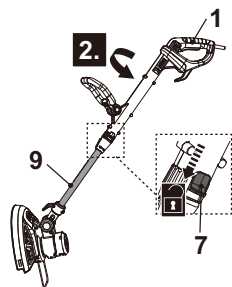

Fig. 7 B  
(initial position 180°)



**WARNING!** Always ensure that the unlock button (7) snaps into place after adjusting the main handle in one of the end positions! Never adjust to an intermediate position!

## Trimmer head tilt adjustment

Tilt the angle of trimmer head (12) to fit the ground conditions for trimming or edging use by aligning the indicator (10a) with the indication line (10b) (Fig. 8).

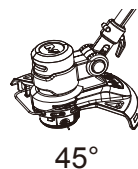
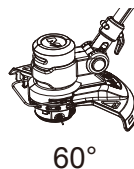
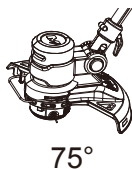
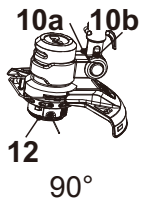

## Trimmer head tilt adjustment

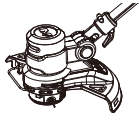

30°

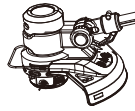

15°

Fig. 8



0

1. Press the unlock button (10) and hold it in position.
2. Move the lower pole (9) slightly up or downward (Fig. 9).
3. Release the unlock button (10) and keep moving the lower pole (9) until it locks in place.

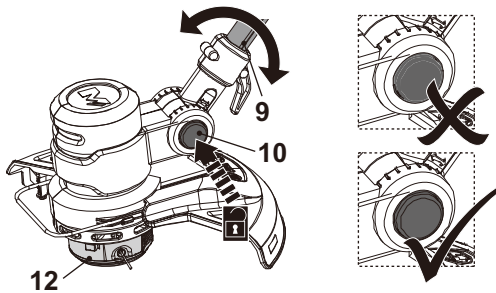

Fig. 9



**WARNING!** Always ensure that the unlock button (10) snaps into place after adjusting the trimmer head (12) in one of the required positions! Never adjust to an intermediate position!

## Plant protector

Use the plant protector (13) to keep distance to obstacles that could be hit by the cutting device.



**WARNING!** Adjust the plant protector position only when the product is switched off and the cutting device is at a complete stop!

1. Pull the plant protector (13) out until it locks in place for trimming / edging operation (Fig. 10).

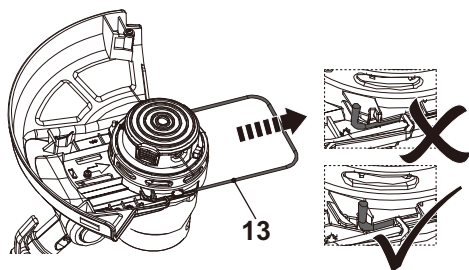

Fig. 10, trimming / edging position

2. Push the plant protector (13) in for transport and storage (Fig. 11).

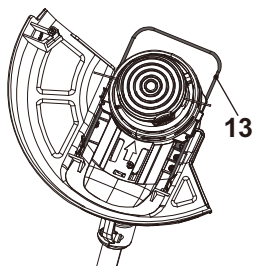

Fig. 11, storage position

## Guard

The guard (11) protects the operator against thrown objects during operation. It is equipped with a knife (11b) that cuts the trimming lines (12d) (Fig. 12).

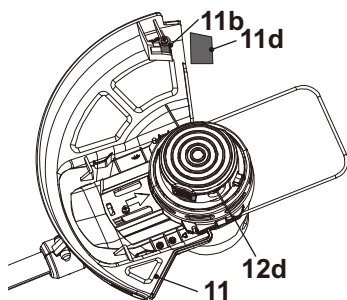

Fig. 12



**NOTE:** Always remove the knife protector (11d) before use.

## Switching on/off

1. Hold the product with one hand at the auxiliary handle (15) and with the other at the main handle (1).
2. Squeeze the on/off switch (2) to switch the product on (Fig. 13).
3. Release the on/off switch (2) to switch the product off.

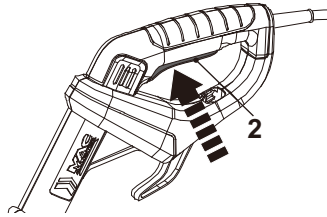

Fig. 13

## General operation

1. Check the product, its power cord and plug as well as accessories for damage before each use. Do not use the product if it is damaged or shows wear.
2. Double check that the accessories and attachments are properly fixed.
3. Always hold the product on its handles. Keep the handles dry to ensure safe support.
4. Ensure that the air vents are always unobstructed and clear. Clean them if necessary with a soft brush. Blocked air vents may lead to overheating and damage the product.
5. Switch the product off immediately if you are disturbed while working by other people entering the working area. Always let the product come to complete stop before putting it down.
6. Do not overwork yourself. Take regular breaks to ensure you can concentrate on the work and have full control over the product.



**WARNING!** Ensure the extension cord will not touch the trimmer head (12) or the trimming line (12d) during operating!  
Danger of electric shock!

## Trimming

1. Make sure that the knife protector (11d) is removed and the plant protector (13) is pulled out before operation.
2. Adjust the main handle (1) angle to 0° for trimming.
3. Hold the product firmly with a gap between the product and your right side.
4. Stand upright, do not lean forward and pay attention to posture. Keep both feet apart to help retain your balance.
5. Hold the trimmer head (12) just above the ground at an angle of approximately 30° (Fig. 14).
6. Move the product with a slow regular arc from left to right before moving it back to the starting position before trimming the next area (Fig. 15).



Fig. 14



Fig. 15

7. Ensure the cutting device remains clean and free from off-cuts that may cause it to jam. Check regularly. Release the on/off switch (2) and disconnect the product from the power supply before checking.
8. Trim longer grass in stages; do not cut long grass in one cut (Fig. 16). For the best results, cut longer grass in steps (Fig. 17).

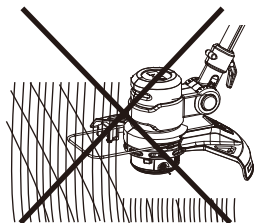

Fig. 16

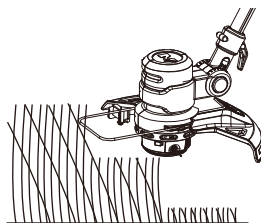

Fig. 17



## Edging

1. Make sure that the knife protector (11d) is removed and the plant protector (13) is pulled out before operation.
2. Adjust the main handle (1) angle to 90° or 180° for edging (Fig. 18).

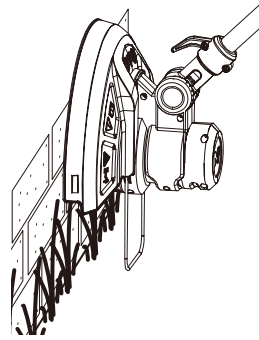

Fig. 18

## Tips

1. For best results, do not cut wet grass because it tends to stick to the cutting head and guard, prevents proper discharge of grass trimmings, and could cause you to slip and fall.
2. Do not allow the spool cover to drag on the ground or other surfaces.
3. Pay special attention when performing the work close to trees and bushes. The cutting head could damage sensitive bark, and damage fence posts.
4. Pull the plant protector (13) out to avoid bringing the cutting device into contact with hard objects such as walls and kerbstones (Figs. 19, 20).

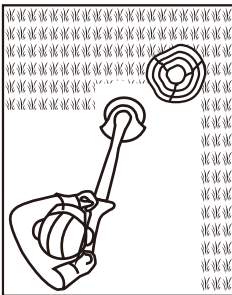

Fig. 19

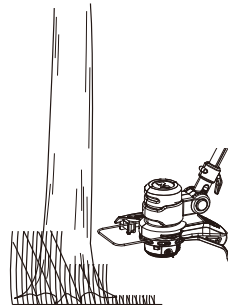

Fig. 20



**NOTE:** The trimming line will wear faster and require more replacement if cutting is done along sidewalks or other abrasive surfaces or heavier weeds are being cut.



**NOTE:** While trimming, the cutting device is possible to be blocked by grass or unevenly ground. So the product will turn off automatically due to over current. Therefore release the on/off switch for over 3s and then press down again to go on with trimming.

## Trimming Line feeding

During use, the tip of the trimming lines (12d) will get shorter due to wear and the trimming line may break. Regularly check the condition of the trimming lines (12d) and adjust if necessary.



**WARNING!** Always switch the product off, disconnect the product from the power supply and let the product cool down before performing inspection, maintenance and cleaning work!



**NOTE:** This product is equipped with an auto-feed head. Do not bump the trimmer head on the ground as this would damage the product.

### Manual feeding

1. Turn trimmer head (12) upside down.
2. Press the release push button (12g) while pulling on the trimming lines (12d). The trimming spool (12c) will release the trimming lines (Fig. 21).

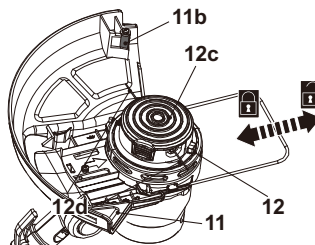

Fig. 21

3. Repeat until the worn part of the trimming lines (12d) exceeds the distance to the knife (11b).
4. Switch the product on and use the product as described. Excess line will be cut by the knife (11b) and should always remain inside the radius of the guard (11).

## Trimming Line feeding



**WARNING!** The trimming line will be thrown out! Danger of injury especially for bystanders!



### Auto-feeding

1. With the product running, release on/off switch (2) to let it stop completely.
2. Press the on/off switch (2) to start the product.



**NOTE:** The trimming line will extend about 3-5 mm with each stop and start until the line reach the length of the knife. Avoid stop and start frequently as the trimming line may auto-feed unintentionally and causes waste a lot of line.

### After use

1. Switch the product off, disconnect the product from the power supply and let it cool down.
2. Attach the knife protector (11d) if necessary.
3. Check, clean and store the product as described below.

## The golden rules for care



**WARNING!** Always switch the product off, disconnect the product from the power supply and let the product cool down before performing inspection, maintenance and cleaning work!



1. Keep the product clean. Remove debris from it after each use and before storage.
2. Regular and proper cleaning will help ensure safe use and prolong the life of the product.
3. Inspect the product before each use for worn and damaged parts. Do not operate it if you find broken and worn parts.



**WARNING!** Only perform repairs and maintenance work according to these instructions! All further works must be performed by a qualified specialist!

## General Cleaning

1. Clean the product with a damp cloth and pH-neutral soap. Use a brush for areas that are hard to reach.
2. In particular clean the air vents after every use with a cloth and brush.
3. Remove stubborn dust with high pressure air (max. 3 bar).



**NOTE:** The trimming line will extend about 3-5 mm with each stop and start until the line reach the length of the knife. Avoid stop and start frequently as the trimming line may auto-feed unintentionally and causes waste a lot of line.

4. Check for worn or damaged parts. Replace worn parts as necessary or contact an authorised service centre for repair before using the product again. Check for worn or damaged parts. Replace worn parts as necessary or contact an authorised service centre for repair before using the product again.

## Guard

1. Keep the guard (11) clean and free of debris. Remove trimmings.
2. Replace the guard (11) with one of the same type when it is worn or shows damage.

## Trimming line

### Replace the trimming spool

Replace the line spool when it is empty or worn.

1. Turn the product upside down to access the trimming lines.
2. Hold the trimmer head (12) steady with one hand. Press the release latches (12b) on both sides, then lift the cover (12a) and remove it (Fig. 22).
3. Remove the trimming spool (12c) from the housing (12e) (Fig. 23).

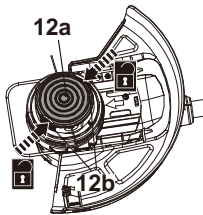

Fig. 22

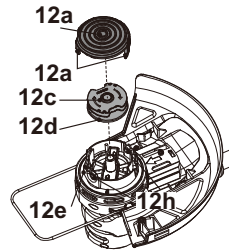

Fig. 23

4. Clean the housing (12e) before inserting a new spool (12c) of the same type.
5. Pull one trimming line (12d) from the new spool for a length of approx. 14 cm.
6. Release the trimming line (12d) from the notches and hold it in position. Avoid the trimmer line (12d) scattered from the trimming spool (12c) (Fig. 24, Step 1).
7. Lead the trimming line ending through the eyelet (12h) on the housing (12e) (Fig. 24, Step 2).
8. Repeat the above steps (from 5 to 7 ) to lead the other trimming line ending through the other eyelet (12h).
9. Insert the trimming spool (12c) into the housing (12e) (Fig. 24, Step 3). Twist the spool until it locks into place.

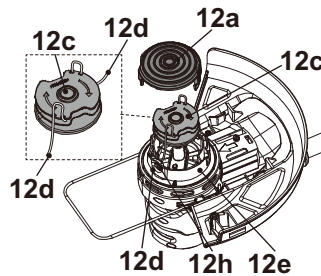

Fig. 24

10. Refit the cover (12a) and make sure it snaps into place.

### Refill the trimming line in the trimming spool

1. Remove the trimming spool (12c) from the housing (12e) as instructed in chapter "Trimming line - Replace the trimming spool".

2. Discard all the remaining lines (12d) from the trimming spool (12c).
3. Clean the housing (12e) and the trimming spool (12c).
4. Cut two new 3 m long trimming lines with a diameter of 1.6 mm.
5. Lead one end of the new trimming lines (12d) through the small eyelet on the trimming spool (12c) in direction of the arrows (Fig. 25).
6. Insert two trimming lines (12d) all the way until the end then bend them over.

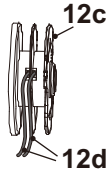

Fig. 25

7. Wind all the trimming lines firmly around the trimming spool (12c) in direction of the arrows on the trimming spool (12c) (Fig. 26).

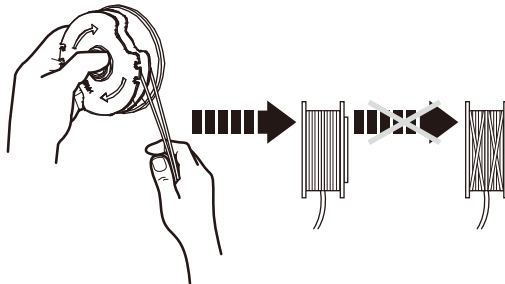

Fig. 26

## Spare parts/Replacement parts

The following parts of this product may be replaced by the consumer. Spare parts are available at an authorised dealer or through our customer service.



## Power cord

If the power cord is damaged, it must be replaced by the manufacturer, its service agent or similarly qualified persons in order to avoid a safety hazard.

## UK plug (only for UK market)

If you need to replace the fitted plug, then follow the instructions below.

**IMPORTANT:** The wires in the mains lead are coloured in accordance with the following code:

Blue – Neutral

Brown – Live

As the colours of the wire in the mains lead of this product may not correspond with the coloured marking identifying the terminals in your plug, proceed as follows. The wire, which is coloured blue, must be connected to the terminal, which is marked with N or coloured black. The wire, which is coloured brown, must be connected to the terminal, which is marked L or coloured red.

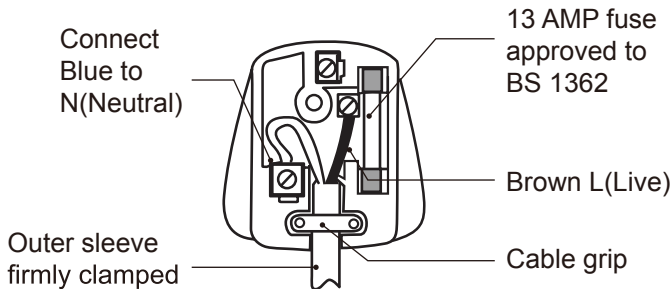

**WARNING!** Never connect live or neutral wires to the earth terminal of the plug, which is marked with E.

Only fit an approved 13 Amp BS 1363 or BS 1363/A plug and the correctly rated fuse.

If in doubt, consult a qualified electrician.



**NOTE:** If a moulded plug is fitted and has to be removed take great care in disposing of the plug and severed cable, it must be destroyed to prevent engaging into a socket.

## Repair

This product does not contain any parts that can be repaired by the consumer. Contact an authorised service centre or a similarly qualified person to have it checked and repaired.

## Storage

1. Switch the product off and disconnect it from the power supply.
2. Clean the product as described above.
3. Push the plant protector (13) in if necessary.
4. Rotate the cord container (rotatable) (5) and make sure that the tip of cord container (rotatable) (5) is pointed backward (Fig. 27).
5. Wrap the power cord (3) onto the two cord containers (5, 9a) and secure it with a suitable cord clip (Fig. 28).

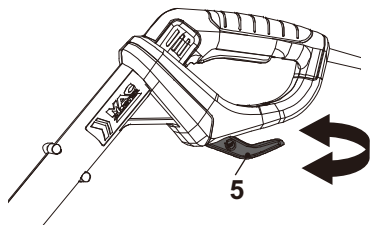

Fig. 27

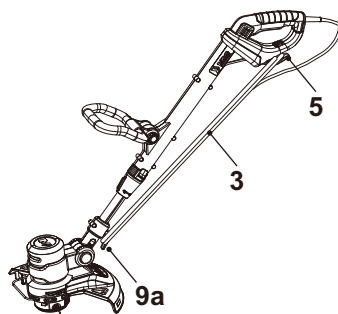

Fig. 28

6. Store the product and its accessories in a dark, dry, frost-free, well-ventilated place.
7. Always store the product in a place that is inaccessible to children. The ideal storage temperature is between 10 °C and 30 °C.

## Transportation

1. Switch the product off and disconnect it from the power supply
2. Attach the knife protector (11d) if necessary.
3. Push the plant protector (13) in if necessary.
4. Always carry the product by two handle bars (1, 15).
5. Protect the product from any heavy impact or strong vibrations which may occur during transportation in vehicles.
6. Secure the product to prevent it from slipping or falling over.



## Troubleshooting

Suspected malfunctions are often due to causes that the users can fix themselves. Therefore check the product using this section. In most cases the problem can be solved quickly.



**WARNING!** Only perform the steps described within these instructions! All further inspection, maintenance and repair work must be performed by an authorised service centre or a similarly qualified specialist if you cannot solve the problem yourself!

Problem	Possible cause	Solution
1. Product does not start	1.1. Not connected to power supply 1.2. Power cord or plug is defective 1.3. Other electrical defect to the product	1.1. Connect to power supply 1.2. Check by a specialist electrician 1.3. Check by a specialist electrician
2. Product does not reach full power	2.1. Extension cord not suitable for operation with this product 2.2. Power source (e.g. generator) has too low voltage 2.3. Air vents are blocked	2.1. Use a proper extension cord 2.2. Connect to another power source 2.3. Clean the air vents
3. Unsatisfactory result	3.1. Trimming line is worn /damaged	3.1. Replace with a new one
4. Excessive vibration or noise	4.1. Trimmer head is damaged 4.2. Bolts/nuts are loose 4.3. Trimming line is worn/ damaged	4.1. Replace with a new one 4.2. Tighten bolts/nuts 4.3. Replace with a new one

In more detail...

## Recycling and disposal

---



Waste electrical products should not be disposed of with household waste. Please recycle where facilities exist. Check with your Local Authority or local store for recycling advice.

**For further information visit [www.recycle-more.co.uk](http://www.recycle-more.co.uk).**

The product comes in a package that protects it against damage during shipping. Keep the package until you are sure that all parts have been delivered and the product is working properly. Recycle the package afterwards.

## Guarantee

---

We take special care to select high quality materials and use manufacturing techniques that allow us to create products incorporating design and durability. This product has a manufacturer's guarantee of 2 years against manufacturing defects, from the date of purchase (if bought in store) or date of delivery (if bought online), at no additional cost for normal (non-professional or commercial) household use.

To make a claim under this guarantee, you must present your proof of purchase (such as a sales receipt, purchase invoice or other evidence admissible under applicable law), please keep your proof of purchase in a safe place. For this guarantee to apply, the product you purchased must be new, it will not apply to second hand or display products. Unless stated otherwise by applicable law, any replacement product issued under this guarantee will only be guaranteed until expiry of the original period guarantee period.

This guarantee covers product failures and malfunctions provided the product was used for the purpose for which it is intended and subject to installation, cleaning, care and maintenance in accordance with the information contained in these terms and conditions, in the user manual and standard practice, provided that standard practice does not conflict with the user manual.

This guarantee does not cover defects and damage caused by normal wear and tear or damage that could be the result of improper use, faulty installation or assembly, neglect, accident, misuse, or modification of the product. Unless stated otherwise by applicable law, this guarantee will not cover, in any case, ancillary costs (shipping, movement, costs of uninstalling and reinstalling, labour etc), or direct and indirect damage.

Rights under this guarantee are enforceable in the country in which you purchased this product. Guarantee related queries should be addressed to the store you purchased this product from.

The guarantee is in addition to and does not affect your statutory rights.

**Manufacturer:**

Kingfisher International Products Limited  
3 Sheldon Square, W26PX London United Kingdom  
[www.kingfisher.com/products](http://www.kingfisher.com/products)

**Distributor:**

B&Q plc

Chandlers Ford, Hants, SO53 3LE, United Kingdom

[www.diy.com](http://www.diy.com)

Screwfix Direct Limited

Trade House, Mead Avenue, Yeovil, BA22 8RT, United Kingdom

[www.screwfix.com](http://www.screwfix.com)

In more detail...

## Technical specifications

### General

>Rated voltage, frequency	: 230-240 V~,50 Hz
>Rated power input	: 450 W
>Rated no load speed $n_0$	: 9000 min <sup>-1</sup>
>Protection class	: II / □
>Degree of protection	: IPX0
>Weight	: approx. 2.55 kg
>Length of power cord	: approx. 10 m
>Dimensions (fully assembled)	: approx. 402*314*1369 mm

### Trimmer head capacity

>Cutting width	: 28 cm
>Trimming line	: nylon, Ø 1.6 mm, length 2*3 m

### Sound values

>Sound pressure level at operator's position $L_{pA}$	: 79.1 dB(A)
>Uncertainty $K_{pA}$	: 3 dB(A)
>Measured sound power level $L_{WA}$ as grass trimmer	: 93.71 dB(A)
>Uncertainty $K_{WA}$	: 0.73 dB(A)
>Measured sound power level $L_{WA}$ as edge trimmer	EU: 94.73 dB(A) UK: 94.73 dB(A)
>Uncertainty $K_{WA}$	: 1.34 dB(A)

### Hand arm vibration values

>Main handle $a_{h,W}$	: 5.81 m/s <sup>2</sup>
>Auxiliary handle $a_{h,W}$	: 3.36 m/s <sup>2</sup>
>Uncertainty K	: 1.5 m/s <sup>2</sup>

The sound values have been determined according to noise test code given in EN 50636-2-91, using the basic standards EN ISO 11201 and EN ISO 3744. The sound intensity level for the operator may exceed 80 dB(A) and ear protection measures are necessary. The declared vibration value has been measured in accordance with a standard test method (according to EN 50636-2 91) and may be used for comparing one product with another. The declared vibration value may also be used in a preliminary assessment of exposure.



**WARNING!** Depending on the actual use of the product the vibration values can differ from the declared total. Adopt proper measures to protect yourself against vibration exposures. Take the whole work process including times the product is running under no load or switched off into consideration.

Proper measures include among others regular maintenance and care of the product and accessories, keeping hands warm, periodical breaks and proper planning of work processes.

## Rating label explanation

---

MGT45028= Model number

M = MAC Allister

GT = Grass Trimmer

450 = Rated power (W)

28 = Cutting width (cm)

# Declaration of conformity

---

In more detail...



**Manufacturer, Fabricant, Producător, Producător, Fabricante:**

**UK Manufacturer:**

Kingfisher International Products Limited  
3 Sheldon Square, London, W2 6PX  
United Kingdom  
[www.kingfisher.com/products](http://www.kingfisher.com/products)

**EU Manufacturer:**

Kingfisher International Products B.V.  
Rapenburgerstraat 175E  
1011 VM Amsterdam  
The Netherlands  
[www.kingfisher.com/products](http://www.kingfisher.com/products)

EN

[www.diy.com](http://www.diy.com)  
[www.screwfix.com](http://www.screwfix.com)  
[www.screwfix.ie](http://www.screwfix.ie)

To view instruction manuals online, visit  
[www.kingfisher.com/products](http://www.kingfisher.com/products)

FR

[www.castorama.fr](http://www.castorama.fr)  
[www.bricodepot.fr](http://www.bricodepot.fr)

Pour consulter les manuels d'instructions en ligne,  
rendez-vous sur le site [www.kingfisher.com/products](http://www.kingfisher.com/products)

PL

[www.castorama.pl](http://www.castorama.pl)

Aby zapoznać się z instrukcją obsługi online, odwiedź  
stronę [www.kingfisher.com/products](http://www.kingfisher.com/products)

ES

[www.bricodepot.es](http://www.bricodepot.es)

Para consultar los manuales de instrucciones en línea,  
visite [www.kingfisher.com/products](http://www.kingfisher.com/products)

PT

[www.bricodepot.pt](http://www.bricodepot.pt)

Para consultar manuais de instruções online, visite  
[www.kingfisher.com/products](http://www.kingfisher.com/products)

RO

[www.bricodepot.ro](http://www.bricodepot.ro)

Pentru a consulta manualele de instrucțiuni online, vizitați  
[www.kingfisher.com/products](http://www.kingfisher.com/products)

TR

[www.koctas.com.tr](http://www.koctas.com.tr)

Kullanım kılavuzuna internet üzerinden ulaşmak için  
[www.kingfisher.com/products](http://www.kingfisher.com/products) adresini ziyaret edin